

COMFORT AIR CURTAIN **STAVOKLIMA**

Installation and operation manual

---

# Li model – underceiling design EN









# 1. Table of Contents

1.	Table of Contents .....	3
2.	Unpacking, check after transport or warehousing .....	4
2.1.	Unpacking and check .....	4
2.2.	Storing of the unit, additional transport recommendations .....	4
2.3.	Safety measures.....	5
3.	Basic information about the unit and its use.....	5
4.	Dimensions of the unit .....	6
4.1.	Suspended ceiling unit – design “OS” with frame.....	6
4.2.	Suspended ceiling unit – design “DP” .....	7
5.	Unit installation .....	8
5.1.	Installation of the unit with rotary suction – “OS including a frame” unit.....	8
5.2.	Installation of the unit to the suspended ceiling – “DP” .....	10
6.	Connection of the unit to heating system .....	11
6.1.	Heat exchanger control using a valve with thermostatic heat.....	12
6.2.	Heat exchanger control with a valve with electrothermic head .....	12
6.3.	Setting of independent valve flow pressure (ETVQ) .....	12
7.	Types of controllers and options for controlling .....	13
7.1.	ECON controller .....	13
7.2.	Ditronic Touch controller .....	14
8.	Electric connection of the unit.....	15
8.1.	Unlocking of emergency thermostat for units with the electric heater.....	15
9.	Commissioning, starting of the unit.....	16
10.	Optional accessories - depending on equipment level .....	16
11.	Basic service and maintenance information.....	16
11.1.	Troubleshooting.....	17
12.	Cleaning/replacement of the filter .....	18
12.1.	Removal of filter from “OS model – rotated suction” .....	18
12.2.	Removal of filter from “DP model – into the suspended ceiling” .....	18
13.	Decommissioning – disposal.....	18
14.	Important notes.....	19

## Explanation of symbols used

 <p>Instructions for mechanical repairs and maintenance.</p>	 <p>Important safety information, technical information, data and device output.</p>
 <p>Important electric information - read carefully - unit damage hazard in case of wrong installation.</p>	 <p>Important information - please read carefully.</p>

## 2. Unpacking, check after transport or warehousing

### 2.1. Unpacking and check

Carefully check the delivery note attached to the delivery. For components identified as extra accessories in the delivery note (not included in the unit or installed therein), please check completeness to the parcel and perfect condition (usually delivered in a separate box). Report any serious damage to packaging or boxes, and make a basic record to the parcel transport documents. Inform the transport company or manufacturer (if the manufacturer arranges transport) immediately.

All packaging material used is environmentally friendly and may be reused or recycled. Dispose of or reprocess the non-environmentally friendly components correctly.

When unpacking, follow the procedure diagrammatically shown below.

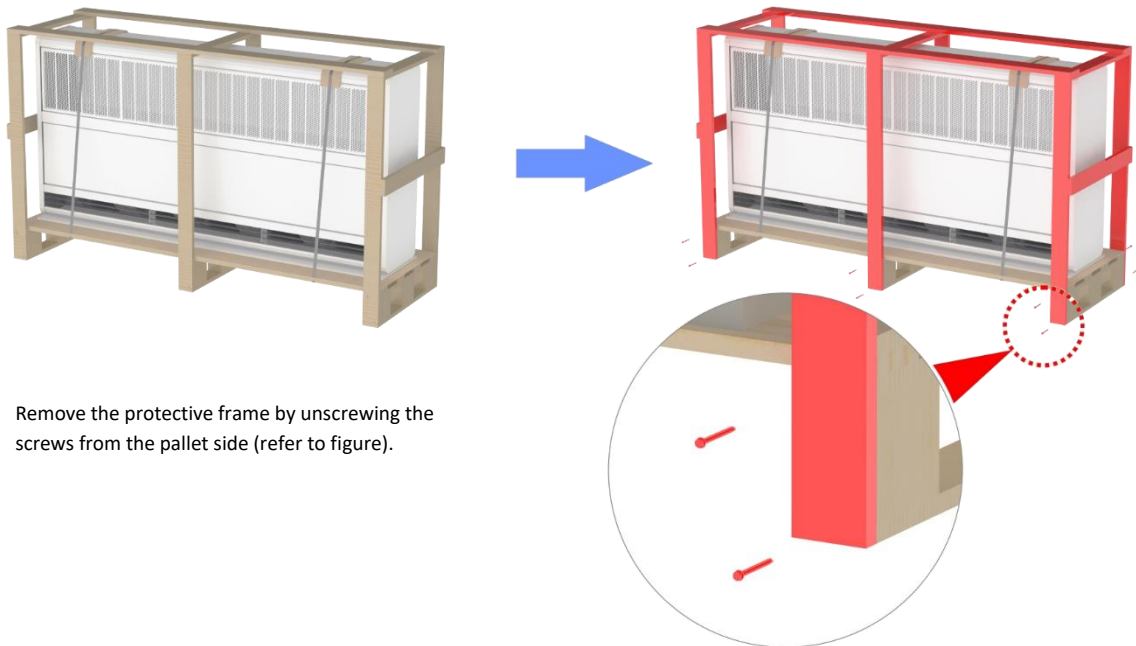

### 2.2. Storing of the unit, additional transport recommendations



- Observe packaging decals on the unit. The device in its packaging must not be turned or placed in transport positions other than those supplied and recommended by the manufacturer. Packaging also contains production number and unit type for easy unit type identification.
- Use genuine packaging for further transport of the unit. The packaging is tested for re-use, and a different packaging may cause damage to the unit.
- Use means with certified sufficient loading capacity for transport and handling; properly qualified persons only may operate the transport means.
- Permissible warehousing conditions:  $-10^{\circ}\text{C} \div 50^{\circ}\text{C}$ , 50-85% humidity without condensation.
- Do not remove genuine packaging until installation is complete (to avoid device damage). At least 2 persons are recommended for safe handling.



## 2.3. Safety measures

The unit has been manufactured in line with the government decrees and Czech standards harmonized with the EU regulations mentioned in the manufacturer's declaration of conformity.

The above mentioned product complies with the following standards:

ČSN EN 60335-1 ed.3                      ČSN EN 60335-2-30 ed. 3  
 ČSN EN IEC 61000-6-2 ed. 4            ČSN EN 61000-6-3 ed. 2

The above mentioned product complies with the following directives:

- Directive 2009/125/EC of the European Parliament and of the Council establishing a framework for the setting of eco-design requirements for energy-related products.
- Government Decree No. 118/2016 Coll. Directive 2014/35/EU of the European Parliament and of the Council on the harmonisation of the laws of the Member States relating to the making available on the market of electrical equipment designed for use within certain voltage limits.
- Government Decree No. 117/2016 Coll. Directive 2014/30/EU of the European Parliament and of the Council on the harmonisation of the laws of the Member States relating to electromagnetic compatibility.
- Government Decree No. 481/2012 Coll. (Regulation of the European Parliament and of the Council No. 2014/35/EU, Regulation of the European Parliament and of the Council No. 2011/65/EU).
- Government Decree on restriction the use of some hazardous materials found in electrical and electronic products.

Observe generally applicable national provisions and other related regulations. Unplug the unit from mains before any service intervention. Connection and earthing of the electric device or components thereof must be in line with laws applicable in the country of use. Only qualified staff may carry out any electric service works.

Observe applicable laws, in particular:

- on safety of electric and thermal appliances,
- on central heat distribution systems,
- on fire safety,
- do never exceed working pressure and temperature specified in the production label.



Follow standards and rules applicable in the country of use, in particular the fire safety of appliances and heat sources, and the fire technical properties of materials - flammability levels. Place the unit 150mm from B, C1, C2 level flammable materials, and 400mm and 1000mm for C3 level easily flammable materials in the radiation direction (air flow from the unit).

## 3. Basic information about the unit and its use

An air unit is a device, which produces a natural air barrier against penetration of cold air into heat environment (in summer, it operates as a protection against penetration of hot summer air to the spaces being either cooled or air conditioned). These devices are suitable for basic and non-aggressive environments. The permitted temperature range in the space is 5–40 °C.

For the curtaining purposes, either circulation air of the environment temperature or the circulation air heated by hot-water or electric heater may be used. The use of the device can save high cooling costs in the air conditioned spaces. Full performance of the unit may be provided only when maintenance is regular and proper. All controls are accessible and well maintained.

Technical conditions for unit operation:



- max. media working temperature 90°C/pressure 1.6MPa – unless specified otherwise,
- hot water working voltage – 230V/50Hz, electric heater unit working voltage - 400V/50Hz ,
- max. surrounding temperature 40 °C,
- IP rating of hot water unit - IP 20/IP rating of electric heater unit - IP 20,
- the unit is intended for basic and non-aggressive environment,
- the hot water units are equipped with a filter - use only the filters supplied by the manufacturer!
- minimum pressure difference 23kPa must be provided for use of a 2W valve (applies only to a pressure-independent valve).

## 4. Dimensions of the unit

### 4.1. Suspended ceiling unit – design “OS” with frame

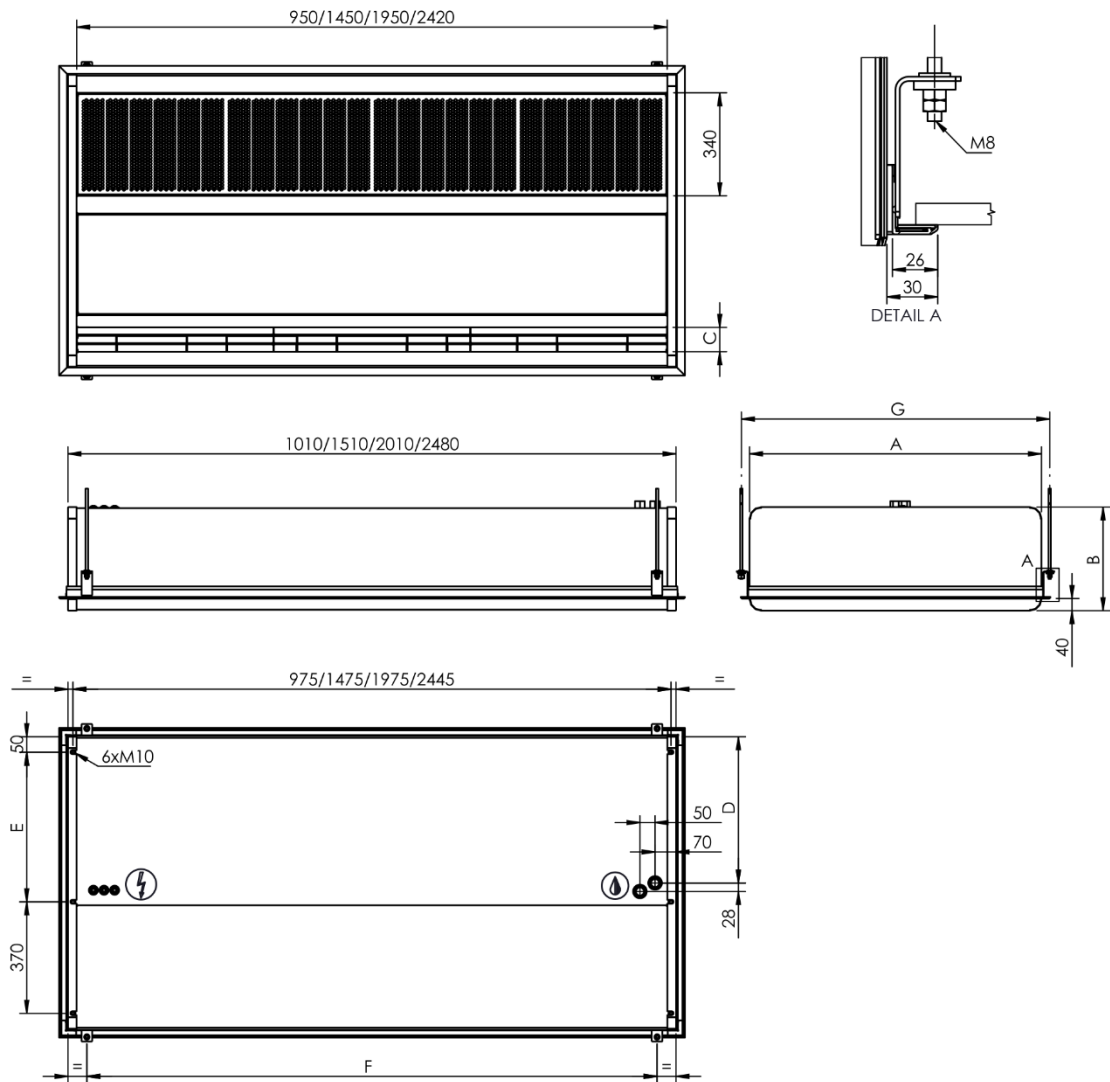

“OS” model	Dimensions (mm)							
	A	B	C	D	E	F	G	Exhaust height
THCP-100-3-Li0	965	345	80	485	495	1x910	1020	2500
THCP-150-3-Li0	965	345	80	485	495	1x1385	1020	2500
THCP-200-3-Li0	965	345	80	485	495	1x1885	1020	2500
THCP-250-3-Li0	965	345	80	485	495	2x1180	1020	2500
THCP-100-3-Li1	965	345	80	485	495	1x910	1020	2800
THCP-150-3-Li1	965	345	80	485	495	1x1385	1020	2800
THCP-200-3-Li1	965	345	80	485	495	1x1885	1020	2800
THCP-250-3-Li1	965	345	80	485	495	2x1180	1020	2800
THCP-100-3-Li2	1000	390	100	515	530	1x910	1055	3500
THCP-150-3-Li2	1000	390	100	515	530	1x1385	1055	3500
THCP-200-3-Li2	1000	390	100	515	530	1x1885	1055	3500
THCP-250-3-Li2	1000	390	100	515	530	2x1180	1055	3500

4.2. Suspended ceiling unit – design “DP”

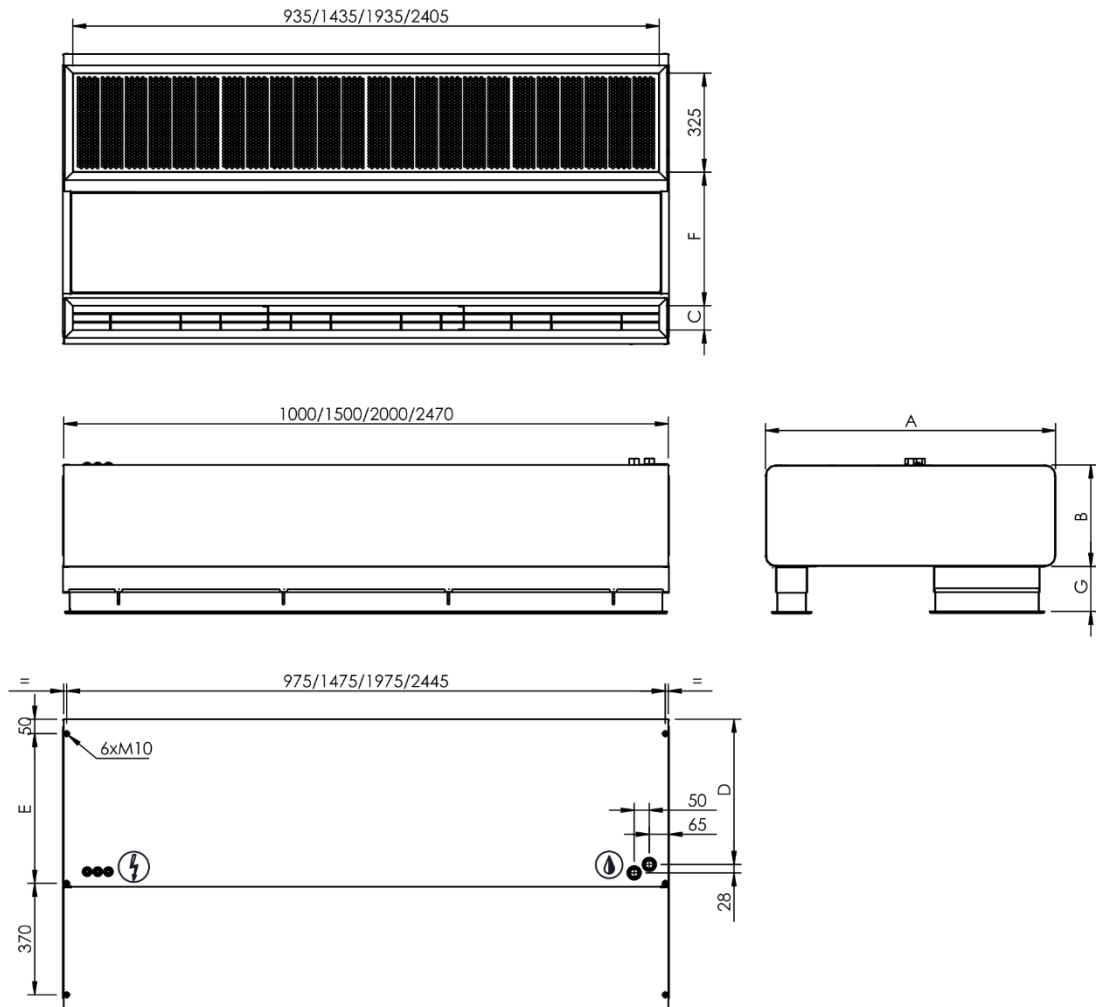

“DP” model	Dimensions (mm)								Exhaust height
	A	B	C	D	E	F	G		
							Min.	Max.	
THCP-100-3-Li0	965	345	80	485	495	440	100	150	2500
THCP-150-3-Li0	965	345	80	485	495	440	100	150	2500
THCP-200-3-Li0	965	345	80	485	495	440	100	150	2500
THCP-250-3-Li0	965	345	80	485	495	440	100	150	2500
THCP-100-3-Li1	965	345	80	485	495	440	100	150	2800
THCP-150-3-Li1	965	345	80	485	495	440	100	150	2800
THCP-200-3-Li1	965	345	80	485	495	440	100	150	2800
THCP-250-3-Li1	965	345	80	485	495	440	100	150	2800
THCP-100-3-Li2	1000	390	100	515	530	460	100	150	3500
THCP-150-3-Li2	1000	390	100	515	530	460	100	150	3500
THCP-200-3-Li2	1000	390	100	515	530	460	100	150	3500
THCP-250-3-Li2	1000	390	100	515	530	460	100	150	3500

## 5. Unit installation



Prior to the air curtain assembly, have prepared power supply at the point of installation conforming to the electric parameters of the installed air curtain and attached wiring diagram.

In case of the air curtain with hot-water heater, hot water supply must be available in advance.

The door unit is suspended in six (or eight for the unit of the length of 2500mm) suspension points on the unit casing. The suspension points are accessible from outside and rivet nuts (M10 threads) are installed on the unit from production plant.

Upon special purchase order, the following is supplied as accessories to the ZSA under-ceiling suspensions:

6 pcs of M10x1000 threaded bar, 6 pcs of M10/40 anchors, 6 pcs M10 left-right suspension sleeve, 6 pcs of M10 left-right bolt, 12 pcs M10 nuts (for assembly refer to figure on the right).



Pay attention to correct fitting of all nuts to all assembly components. Pay attention to the end position of the threads to avoid loosening and falling the unit by rotation.

Use quality anchors and wall plugs only. Consider installation situation and suitability of anchoring and installation material, including loading capacity of the structure properly. The manufacturer accepts no liability for improperly used wall plugs or other installation and hanging material!

Following the assembly, check for horizontal position in both directions. Make sure that tightening up of individual hangers and sleeves do not cause crossing and twisting of the unit. Always properly consider loading capacity of the ceiling or of the wall. Install the device to structurally solid beams.

Always suspend the device to all suspension points.

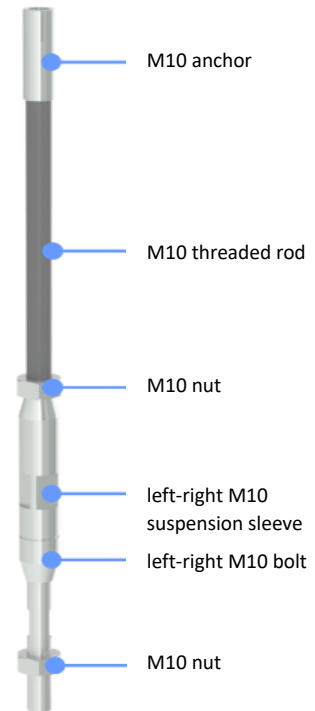

### 5.1. Installation of the unit with rotary suction – “OS including a frame” unit



Assembly procedure:

1. Measure the position of the unit and its distance from the ceiling.
2. Mark the anchoring points and drill the ceiling holes for installation of anchors.
3. Cut the threaded bars to required length.
4. Attach left-right bolt into the unit, fasten with nuts, and rotate left-right suspension sleeves on the bolt.
5. Fit the threaded rods into the prepared ceiling anchors and rotate the nuts.
6. Set the unit into the required position (refer to figure 1 on the page 9) and tighten up the suspension sleeve to the threaded bars until the required connection is made (refer to figure 2 on the page 9), then secure the sleeve with nuts.
7. Hang the covering frame using the M8 threaded bars (refer to figure 3 on the page 9).
8. Level the frame to correct position with respect to the air curtain (refer to figure on the right and 4 on the page 9).

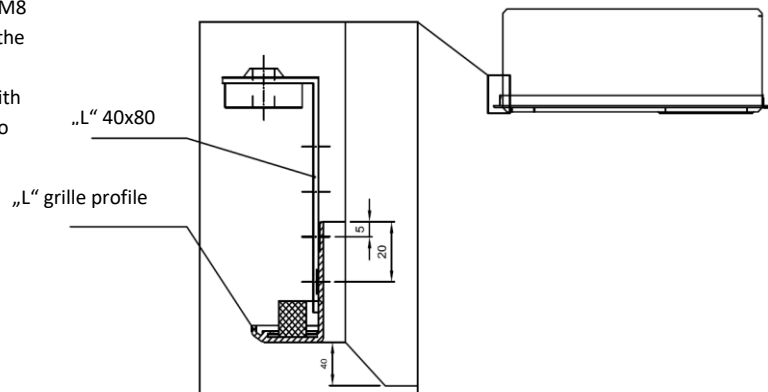



Li comfort air curtain – suspended ceiling version

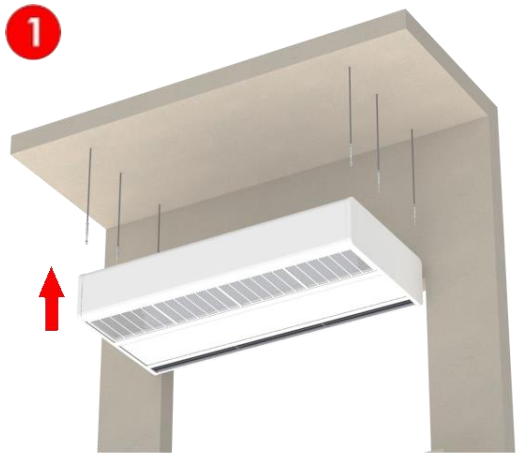

## 5.2. Installation of the unit to the suspended ceiling – “DP”



For mounting above the ceiling, the air curtains are fitted with height adjustable adaptors to allow for suction and exhaust when installed in the suspended ceiling. The air curtain is installed to the suspended ceiling for aesthetic reasons or due to limited space for hanging the same between the door frame and ceiling.

Assembly procedure:



1. Measure the position of the unit and its distance from the ceiling.
2. Mark the anchoring points and drill the ceiling holes for installation of anchors.
3. Cut the threaded bars to required length.
4. Attach left-right bolt into the unit, fasten with nuts, and rotate left-right suspension sleeves on the bolt.
5. Fit the threaded rods into the prepared ceiling anchors and rotate the nuts.
6. Set the unit into the required position (refer to figure 1 below) and tighten up the suspension sleeve to the threaded bars until the required connection is made (refer to figure 2 below), then secure the sleeve with nuts.
7. Adjust the height of the suction and exhaust adaptor depending on the conditions of neat suspended ceiling, and fix at required position. Minimum and maximum height of the adaptors is 100mm and 150mm, respectively.
8. Clean up the suspended ceiling and install the covering exhaust and suction grid (including the filter) to the adaptors prepared using the installation material (refer to figure 3 below).

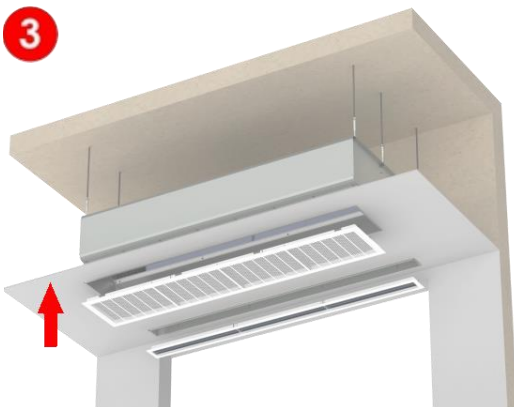
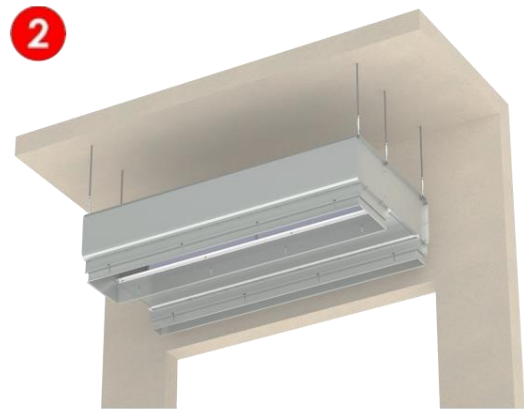

The DP model has no revision door for service intervention in the air curtain! When installing to full suspended ceiling (e.g. plasterboard), it is recommended to have the service door into the suspended ceiling.

## 6. Connection of the unit to heating system



Please check all hot water connections for readiness and perfect condition before connecting media to the unit. Furthermore, please check the hot distribution for components or other measures to ensure zero transmission of static, dynamic, and dilatation forces at the input and output neck connections. No excessive force may be applied when connecting the hot water circuit of the building to the unit's heat exchanger. By the neck of the air conditioner there is a mark that notes use of two keys so that no stressing of the necks occurs in the course of tightening or loosening. **When bolting and tightening up the screw union of the heat exchanger must be secured by a clamp against undesired rotation that may subsequently result in deformations or damage to pipe necks on the heat exchanger.**

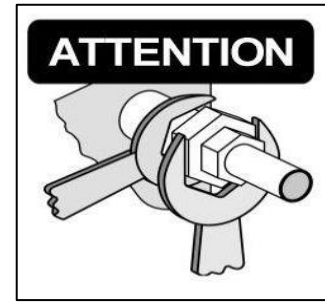

Considering the above the manufacturer clearly recommends that flexible connection hoses are used for connection of the heat exchanger necks (available as PPH accessories, length 300mm, DN20, 25, 32), or a bellows compensator.

Any non-compliance with the instructions above results in rejection of any complaint.

By default, neck for the hot water heater is located on the right hand side on the upper part of the unit (may be placed elsewhere upon request). The inputs are identified by round marks – **medium input red** with arrow pointing inside, and **medium output blue** with arrow pointing outside.

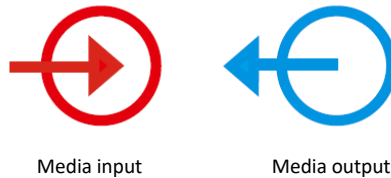

Do not swap the return and supply neck positions - this may cardinaly change performance and parameters of the heater with consequent impact on the hydraulic system. Do not exceed max temperature and pressure for which the unit is rated.

If required, the valve may be embedded in the unit. Some types of the valves may not be placed in the unit for room reasons (located outside the equipment). The value of thermostatic head is pre-set, and the function of the electrothermic valve drive is given by a control type. The connection is then made directly on the neck for media input (third neck is blind). For setting up the thermostatic head, refer to article 6.1 of the function of the electrothermic drive, refer to article 6.2.

Pay attention to quality of media fed to the unit; check for installation of cleaning valve downstream the unit (not included in the supply). Observe max temperature and media pressure to avoid heat exchanger damage. To make sure the heat exchanger operates correctly, drain the exchanger (sludge valve) and purge the cleaning valve because construction or assembly impurities may be present in the system. Deaerate the heat exchanger for perfect operation of the heat exchanger. Install the closing valves on both pipes downstream the unit (ball valves) . Connection thread right above the unit must be removable and not fixed.

As required by the customer, an embedded 2-way or 3-way valve with control head can be delivered for the hot water heat exchanger. The valve drive may be either self-acting (thermostatic) or electrothermic.

Instructions for electric connection of the valve is included in the wiring scheme for connection of the unit. Specific wiring scheme or valve instructions are available upon request only.

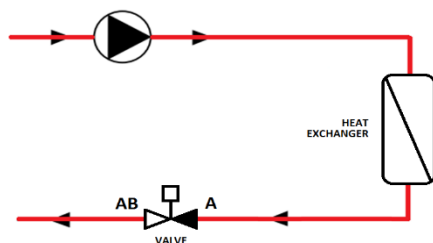

Connection of 2-way TV, ETVQ valve

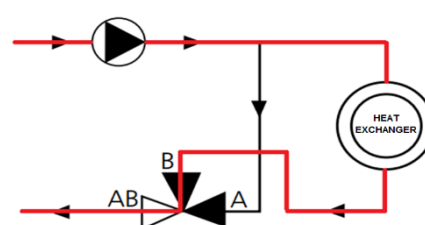

Connection of 3-way TVT, ETVT valve

### 6.1. Heat exchanger control using a valve with thermostatic heat

The thermostatic head for 2-way (TV) and 3-way (TVT) valves is always supplied with the sensor separated (temperature range 25–65 °C) – exhaust air temperature control. Setting of the required closing temperature is made on the head scale (1–5). Temperature degrees with respect to the numbers on the head are expressed as follows:

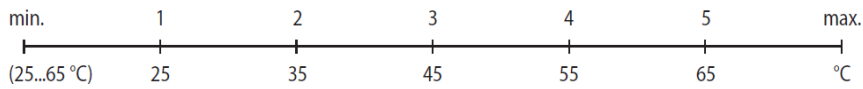

### 6.2. Heat exchanger control with a valve with electrothermic head

The electrothermic valve drive can be supplied to the hot water heat exchanger as embedded either as 2-way (ETVQ) or 3-way (ETVT).

“Normally open” version (NO).

When the thermal drive is under voltage, the electrically heated sensor heats up. Upon “dead time” expiration for continuous opening of thermic drive due to cooling down of the sensor.

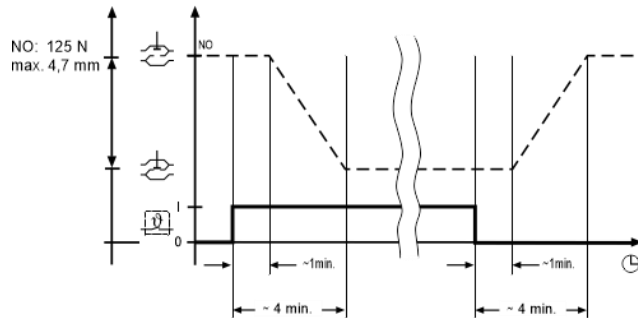
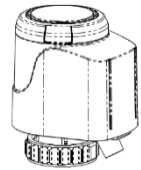

Note:

The time delay (dead time) needs to be considered during the functional test; the opening and closing time depends on surrounding temperature. Electric data: 230V/50Hz-3V, IP 54.

### 6.3. Setting of independent valve flow pressure (ETVQ)

**Setup**

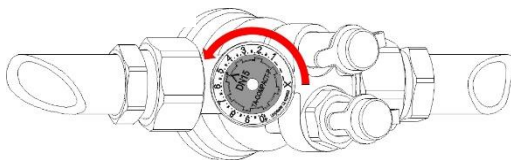

Turn the setting wheel to required value, e.g., 5.0.

**Closing**

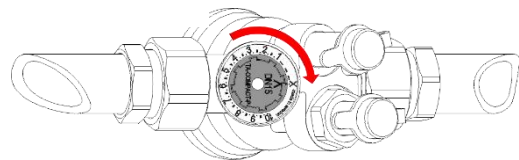

Turn the setting wheel counterclockwise to position X.

**q<sub>max</sub> values**

**Setup**

	1	2	3	4	5	6	7	8	9	10
DN 25	370	610	830	1050	1270	1490	1720	1870	2050	2150
DN 32	800	1220	1620	2060	2450	2790	3080	3350	3550	3700

q<sub>max</sub> = l/h for each setting with the control cone fully open

## 7. Types of controllers and options for controlling

### 7.1. ECON controller



The ECON controllers are intended for control of the fan and electric heater (hot water and electric) with possible connection of external components (door contact, room or exhaust thermostat). These types of basic controls do not allow linking of the controllers (except for Econ DUAL). Controller function is defined by type of the electric documentation. The controller is designed for wall-mounted installation and a separate instructions manual is available.

The ECON DUAL permits controlling of two units at the same time.

For relevant electric wiring scheme, refer the lid for electric connection in the unit. The scheme for a supplied product is valid but it may be modified upon request of the customer or for production reasons depending on a specific request. The connection between the air curtain and the controller is carried out using a 10-wire cable (not included in the supply).

#### Suspended ceiling unit – design „OS“

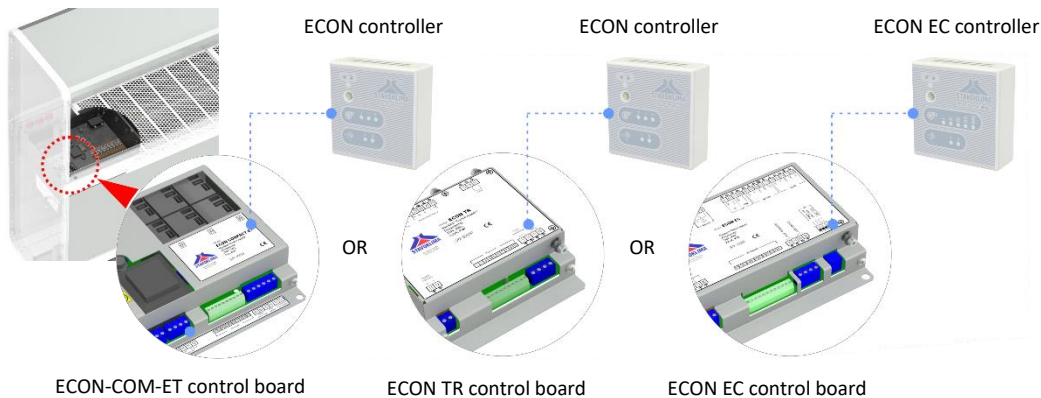

#### Suspended ceiling unit – design „DP“

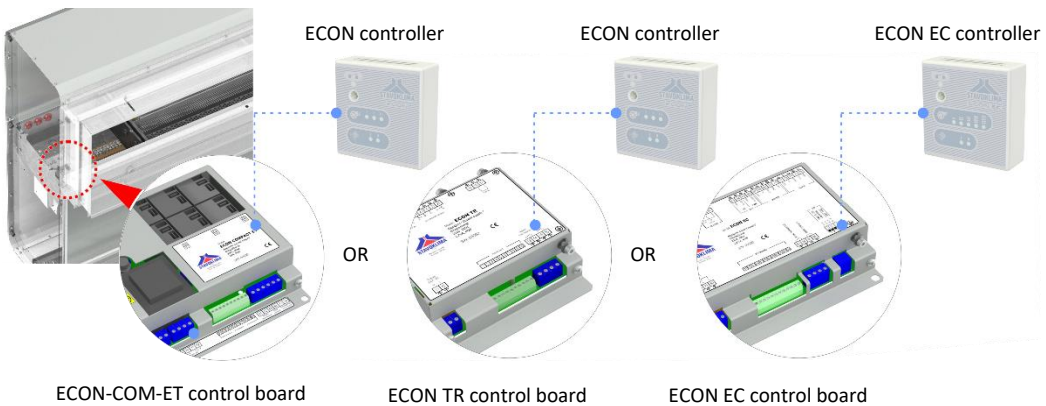

## 7.2. Ditronic Touch controller



The Ditronic Touch controller is highly comfortable controller for fan and heater control (hot water heater and electric one) with optional connection of external elements (door contact, BMS, etc.). Controller function is defined by type of the electric documentation. The controller is designed for wall-mounted installation and a separate instructions manual is available. Included to the controller is the Ni-1000 room sensor to be connected to the control board according to the electric wiring documentation.

The connection between the air curtain and the controller is made using a UTP cable with RJ 45 connector (available as optional accessories in various lengths).

### Suspended ceiling unit – design „OS“

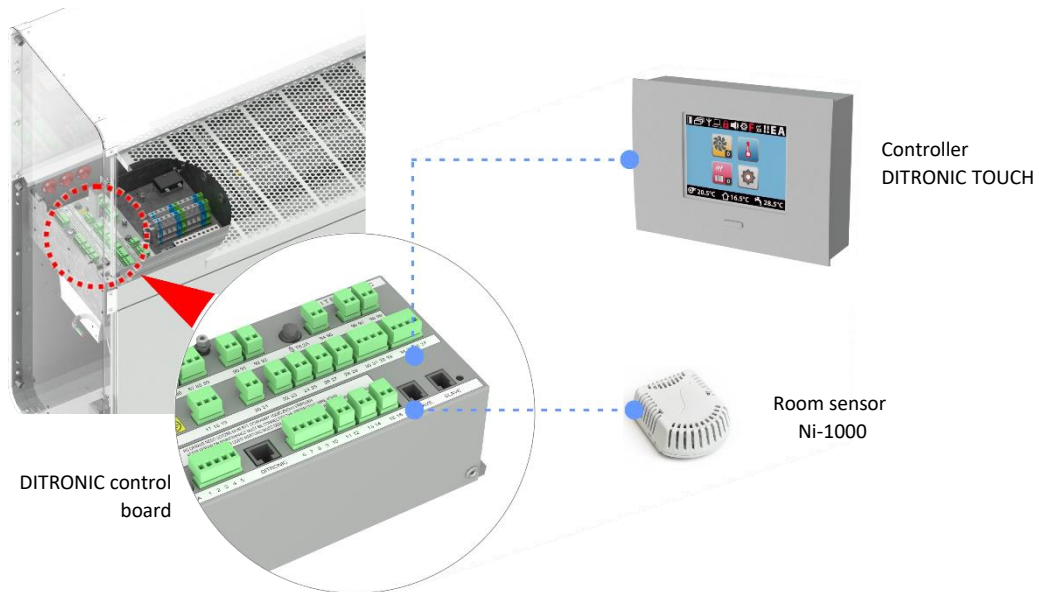

### Suspended ceiling unit – design „DP“

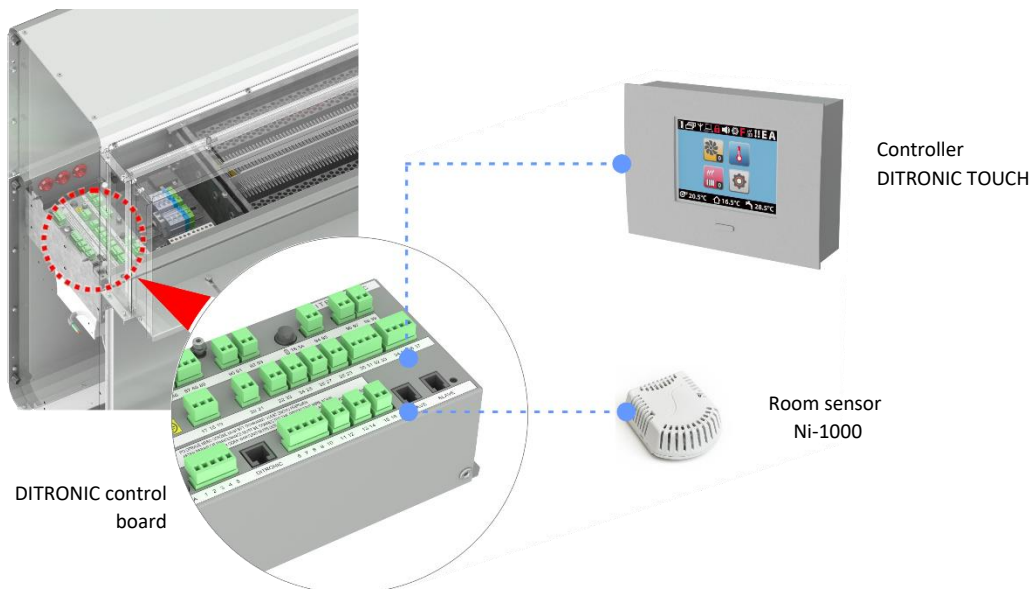



## 8. Electric connection of the unit



The unit must be protected by a suitable circuit breaker according to its electric parameters – refer to attached electric wiring. Connect the ready-to-install cables to the terminals following the attached electric wiring schemes, make connection check, equipotential bonding, and finally turn the power supply on. Use the cable wires with cross section suitably rated according to the current load – refer to electric wiring documentation.

The electric grommets for cable are located always on the opposite side of the standard units than connection of hot water medium. When connecting the electric installation, it is necessary to open the suction grid and unscrew the box lid.

Make sure the cable is neither twisted nor deformed in any way. Keep free ends of the cable wires sufficiently long for easy handling and cut the wire only after you are sure the wire is long enough.

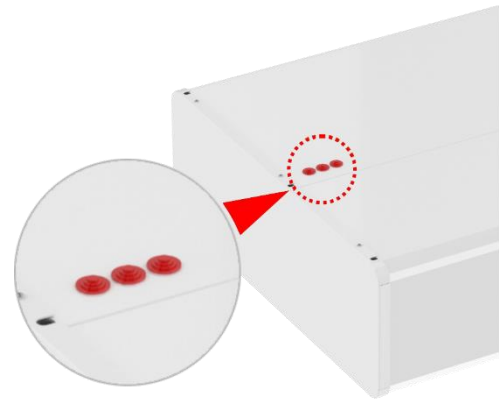

Illustration of bushings for cable

Observe generally applicable national provisions, particularly ČSN 12 2002 and other related regulations. Unplug the unit from mains before any service intervention. Provisions of ČSN 332190, 332000-5-51 ed. 3, and 33 2000-5-54 ed. 3 must be observed for connecting and earthing of the electric devices. Qualified electrician only may perform any electric service works (qualification according to Section 6 of Decree of ČBU No. 50/78 Coll.).



During assembly, carefully check everything and carry out the initial review of the device. Check operation of the FU1-FU3 electric fuses (Ditronic) for interior circuits (for fuse values, refer to the box of electronics), and make sure that the external components (accessories), which may have an essential impact on correct function of the device, operate.

**ATTENTION: The delivery note serves as a warranty sheet!**

### 8.1. Unlocking of emergency thermostat for units with the electric heater



The units fitted with the electric heater are provided with operation thermostat with automatic reset feature (located on each heater) and emergency thermostat with manual reset.

When permitted limit temperature inside the unit is exceeded, heating circuit is turned off by the emergency thermostat = pushbutton sprung up. The button is used to unlock the safety thermostat in case of the device failure. After cooling down the thermostat button needs to be pressed back to default position (refer to figure).



**ATTENTION – unblocking of the emergency thermostat does not resolve failure of the unit! Always remedy the cause of the thermostat overheating!!!**

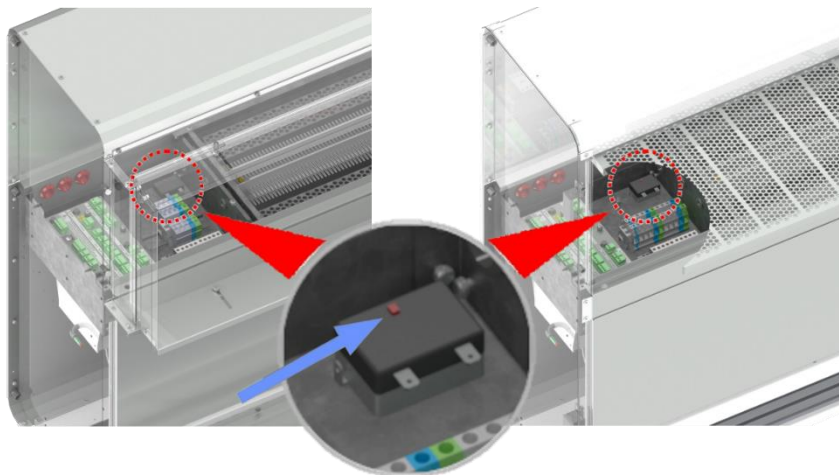

Covering of the air curtain with any strange objects is prohibited ► risk of fire!!!

## 9. Commissioning, starting of the unit

Before commissioning make and check:

- covers and shell of the unit are in perfect condition,
- mechanic fixing and anchoring of the unit,
- ability to remove the filter and its cleanliness,\*/\*\*
- fixing of thermostatic head and its setting,\*/\*\*
- function of circulating pump (not included in the device),\*\*
- correct connection of media and tight connections,\*\*
- tightness and function of the valves,\*/\*\*
- availability of power voltage,
- correct connection of all unit cables,
- fitting and setting of a pre-circuit breaker (not included in the device),
- free from mechanical impurities or objects.

\* if installed

\*\* hot-water version only

Initial review of the electric appliance according to ČSN 331500 and ČSN 33 2000-6-61 ed. 2 must be made upon commissioning.

## 10. Optional accessories - depending on equipment level



The most frequent accessories include thermostatic or electrothermic valves for the temperature control (chapter 6.1 and 6.2). The valves are usually embedded by the manufacturer, for all available valve types refer to the catalogue.

Another accessory used is the door contact (either magnetic or mechanic). The contacts are placed on the door wings or door parts in order to signal the position of the door.

An optional accessories may be e.g., room thermostat, hanging of the unit, 0–10V signal control of the unit over the superior BMS, and more. Selection of an appropriate type of accessories must be supported by the controller type.

For all accessories offered for the unit, refer to the catalogue documentation.

## 11. Basic service and maintenance information



All units are thoroughly checked and tested by the manufacturer before dispatch. The most frequent errors root from misunderstanding of the unit function or incorrect cabling and connection. For this, observe instructions from the manufacturer to avoid complex troubleshooting. In no case try to operate the unit when connected in a different way - the unit may operate for a while as you wish or expect but this irreversible step may result in damage beyond repair and loss. No warranty claims can be accepted with respect to this damage.

The Li - underceiling design air units are made of quality materials that require no special maintenance. However, we recommend that maintenance in required or shorter (depending on your observations due to operation in a specific application) intervals is carried out for long lifecycle of the unit.



**Before any work with the unit, disconnect the electric power supply, mains supply for the unit. Electric shock hazard!!!**

Observe generally applicable national provisions, particularly ČSN 12 2002 and other related regulations. Unplug the unit from mains before any service intervention. Provisions of ČSN 332190, 332000-5-51 ed. 3, and 33 2000-5-54 ed. 3 must be observed for connecting and earthing of the electric devices. Qualified electrician only may perform any electric service works (qualification according to Decree of ČBU No. 50/78 Coll., § 6 is required).

Please contact your vendor or distributor for a service agreement. You will get regular service and excellent care of your unit.





Quarterly checks:

- Unit hanging and tightening of all bolt connections. Check tightening of bolts of exhaust splines - accessible from internal side wall of the unit, tighten the central splines by turning the splines (by tightening of the internal thread pin).
- Heat exchanger space check and remove dirt or foreign objects (use vacuum cleaner for dedusting, or steam for stuck dirt). When using steam for removal of dirt, always proceed downstream the air flow. Set as lowest temperature as possible and as lowest steam pressure as possible for not to damage the heat exchanger by cleaning (remove filter before cleaning – filter damage hazard).\*
- Check cleanliness of the motor body and inner or outer parts of the unit. Do not wash the motor body with water! Wipe with lukewarm towel only – motor winding damage hazard; after the motor is cleaned, do not turn the unit on for 60 minutes – let it dry properly. Proceed carefully when wiping of the exhaust splines - fragile splines - danger of damage!
- Before winter, check in particular the anti-frost protection function, superior circulating pump (not included in the supply of the device), setting of thermostatic or electrothermic valve.\*
- Re-test tightness of the unit or of installed fittings on the water side. If a sludge filter is installed before the unit – clean the filter and check deaeration of the heat exchanger.\*
- Check unit safety with respect to electric shock hazard according to applicable ČSN or national standards, including earthing inspection.
- Thorough cleaning of the suction grid, exhaust splines (tighten up, if necessary).

\* if installed

### 11.1. Troubleshooting

Problem	Possible cause	Remedy
The unit cannot be turned on	Unit circuit-breaker is off	Turn on
	Mains failure	Inspection
	Fuse in the unit	Inspection
	Door contact	Check connection or interconnection
	Anti-frost protection	Inspection
	Controller position "0"	Check, > position than "0"
	External contact	Check connection or interconnection
Noisy motor	Defective motor mount	Check - replacement
	Clogged filter*	Check - replacement
Motor overheats (motor thermal contact turns off)	Defective motor mount or winding	Replace fan unit
	Clogged filter*	Check, clean
	Heavily soiled motor – insufficient cooling	Check, clean
	Excessive temperature of intake air	Inspection
The fan delivers little air only	Excessive temperature of intake medium	Check setup, remove
	Clogged filter*	Check - replacement
Unit is not heating	Soiled heat exchanger	Check - replacement
	Broken or clogged medium supply	Check - replacement
	Little air flows through the heat exchanger	Check - remove
	Soiled heat exchanger splines	Remove
	Insufficient media temperature	Remove
	Medium does not circulate	Check, deaerate
	Temperature achieved in line with controller setup	Controller setup
Automatic operation disconnection	Defective drive of electrothermic valve	Check setup, or replace if defective
	Overheated motor	Find out and clear the cause
	Door contact	Check correct function (refer to controller description)
	External clock	Check correct function (refer to controller description)

\* if installed

## 12. Cleaning/replacement of the filter



Hot-water units are fitted with an air filter. The filter must be cleaned regularly to ensure the efficiency of the unit and its performance levels. The frequency of cleaning depends on local conditions under which the unit operates – checking of the filter and cleaning thereof is recommended at least monthly. Clogged filter does not stand for a safety risk but operation of the unit may deteriorate.

A spare filter can be ordered as optional accessory in the set of 3 pieces. Use genuine filters only. **Use of a filter other than the one approved by the manufacturer is prohibited.**

### 12.1. Removal of filter from “OS model – rotated suction”

1. Easily pull the suction grid to tip it out.
2. Rotate the magnetic safety locks on sides of the filter to release the latter.
3. Remove the filter and get rid of the dust particles. Replace the filter if the clogging is still apparent despite thorough cleaning, or if the fabric is mechanically damaged.

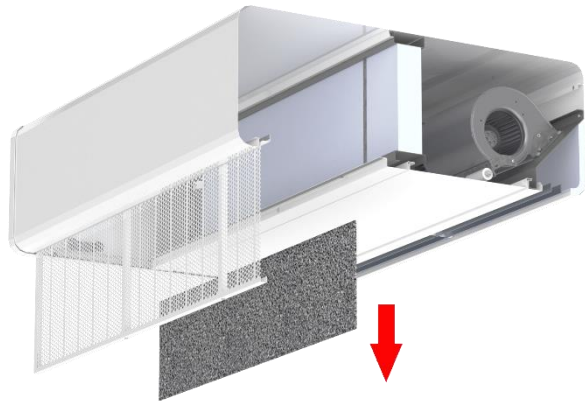

### 12.2. Removal of filter from “DP model – into the suspended ceiling”

1. Use the Allen key to release the screws that secure the suction grid and replace it.
2. Remove the filter from the suction grid and get rid of the dust particles. Replace the filter if the clogging is still apparent despite thorough cleaning, or if the fabric is mechanically damaged.

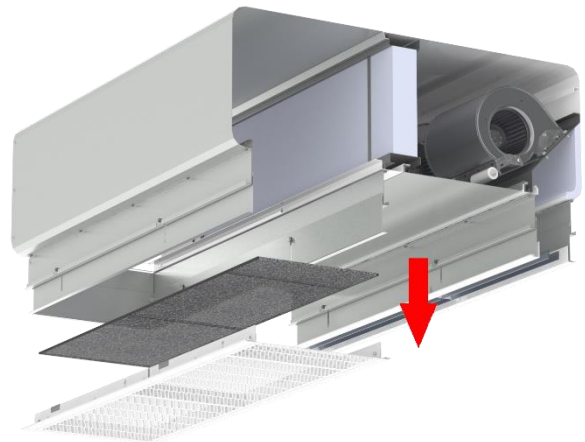

## 13. Decommissioning – disposal



After the expiration of the service life, the unit must be disassembled and disposed of. Only qualified company may disassemble the device. The product or components thereof must be disposed in environmentally-friendly manner at the end of its service life.

The components of the unit must be separated and sorted out by type of material for disposal. Dispose of the metal and plastic components at your local collection yard. The transport packaging of the product is made of common recyclable material (paper, polyethylene, wood) and is labelled as such according to ČSN 77 0052-2.

As far as disposal is concerned, it is operator’s responsibility to comply with applicable national provisions in the country of use. In addition, follow regulations and laws of your country applicable to waste disposal. Separated collection and recycling of the products may help to protect environment and human health.

## 14. Important notes



The door units are intended to avoid heat or cold loss, filtration, and heating, or for ventilation in combination with mixing accessories. Other uses are not intended. The manufacturer accepts no liability for damage resulting from use other than intended. Observe this manual in operation of the units.

Installation, electric connection, and repairs must be carried out by qualified persons according to § 6 of Decree No. 50/78 Coll. or according to applicable national standards and regulations. An expert company is needed to connect the heating medium.

Before the start of the heating season, it is necessary to provide the required amount of heating medium with the design values for units with the hot water heater.

**The manufacturer reserves right to changes for marketing or production reasons without prior notice!**



**STAVOKLIMA s.r.o.**  
Budějovická 450, 370 01 Homole  
Tel.: +420 387 001 931  
e-mail: [info@stavoklima.cz](mailto:info@stavoklima.cz)  
[www.stavoklima.cz](http://www.stavoklima.cz)

